

ZBROJONA SKOŚNA ŚCIANKA PRZEPUSTU

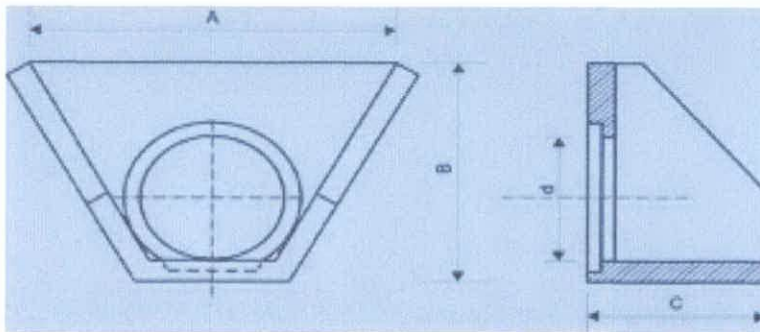

Wykonanie	A	B	C	Ø d	Waga kg
VI	780	600	500	300	225
VII	900	700	500	400	276
VIII	2000	1500	750	800	1306
IX	2000	1500	750	1000	1289

Rys. nr 5